

FI-TYPE

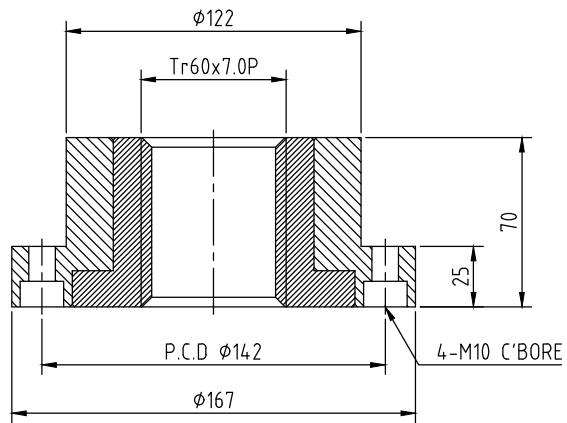

FP-TYPE

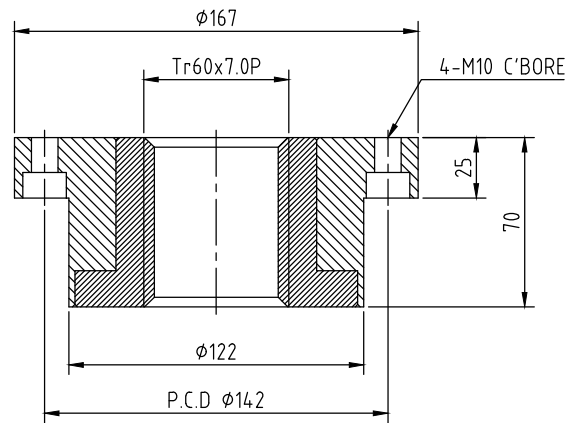

W-TYPE (용접형)

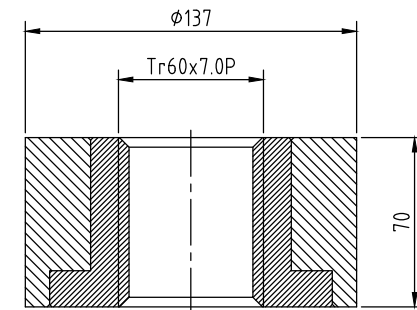

No.	PART		MATERIAL	Q'TY	REMARK	
SIZE	A1	DESIGNED	CHECKED	APPROVED	DATE	ITEM
UNIT	mm	US.Hwang	HJ.Kim	HJ.Kim	21.03.18	WTH-60
SCALE	1 : 1					